

Micro 50

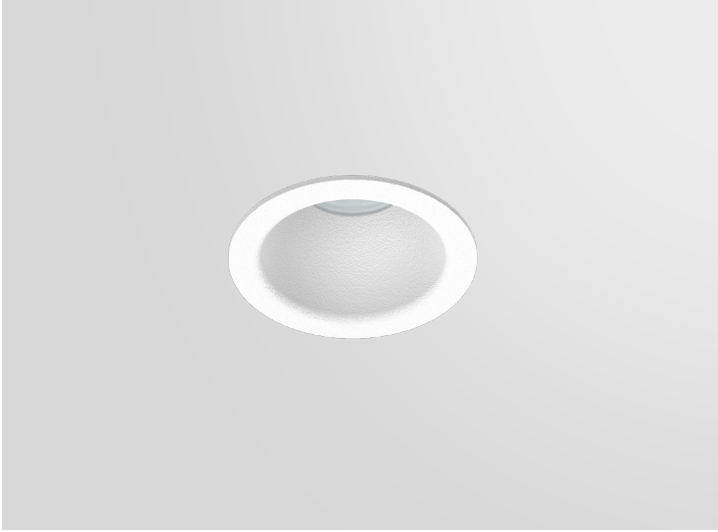

Description

The Micro 50 is a discrete fixed LED downlight that achieves a sleek, trimless appearance without the cost and complexity of plastering in small luminaires. Designed with a deep set soft bezel and a softening lens as standard for maximum visual comfort. The luminaire has been created to blend harmoniously into ceilings spaces.

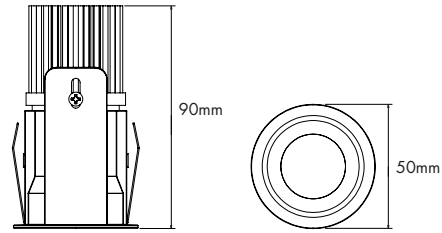

Cut Out: \varnothing 46mm
Ceiling Thickness: 3-25mm

Product Options

Light Source



XOB

Output



Colour Temperature



Colour Fidelity



Beam Angle

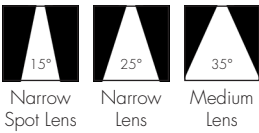

Bezel Colour

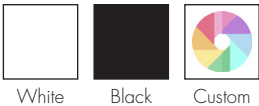

Accessories



Honeycomb Louvre Clear Glass Lens

Product Bulider

	Availability	XOB
Light Source	XOB	<input type="radio"/>
Lumen Output	(05) 500lm (07) 700lm (10) 1000lm	<input type="radio"/> <input type="radio"/> <input type="radio"/>
Colour Temperature	(27) 2700k (30) 3000k (40) 4000k	<input type="radio"/> <input type="radio"/> <input type="radio"/>
Colour Fidelity	(90) Designer Series 90	<input type="radio"/>
Beam Angle	(2L) Narrow Spot Lens 15° (NL) Narrow Lens 25° (ML) Medium Lens 35°	<input type="radio"/> <input type="radio"/> <input type="radio"/>
Bezel Colour	(W) White (B) Black (P) Custom Colour	<input type="radio"/> <input type="radio"/> <input type="radio"/>

M5 _____ /**/**

Control	Accessories
/DD DALI	/HL Honeycomb Louvre
/DP DALI Pro	/CG Clear Glass
/DA 1-10v	
/AP 0.1-10v	
/PH Phase	
/BC BLE Casambi	
Emergency	
/M3 3 hour Maintained	
/ST Self Test	
/DE DALI Emergency	

Key	
Available	<input type="radio"/>
Not Available	-

Micro 50 - XOB

Colour Fidelity		Designer Series CRI90						
		500lm	700lm	1000lm	1300lm	2000lm	3000lm	4000lm
Lumen Output								
Colour Temperature								
2700k	(27)	●	●	●	-	-	-	-
3000k	(30)	●	●	●	-	-	-	-
4000k	(40)	●	●	●	-	-	-	-
Beam Angle								
Narrow Spot Lens 1.5°	(2L)	●	●	●	-	-	-	-
Narrow Lens 25°	(NL)	●	●	●	-	-	-	-
Medium Lens 35°	(ML)	●	●	●	-	-	-	-
Bezel Colour								
White	(W)	●	●	●	-	-	-	-
Black	(B)	●	●	●	-	-	-	-
Custom Colour	(P)	●	●	●	-	-	-	-
Control								
Standard		●	●	●	-	-	-	-
DAII	/DD	●	●	●	-	-	-	-
DAII Pro	/DP	●	●	●	-	-	-	-
1-10v	/DA	●	●	●	-	-	-	-
0.1-10v	/AP	●	●	●	-	-	-	-
Phase	/PH	●	-	-	-	-	-	-
Bluetooth Casambi	/BC	●	●	●	-	-	-	-
Emergency								
3hrs Maintained	/M3	●	●	●	-	-	-	-
Self Test	/ST	●	●	●	-	-	-	-
DAII Emergency	/DE	●	●	●	-	-	-	-
Accessories								
Honeycomb Louvre	/HL	●	●	●	-	-	-	-
Clear Glass Lens	/CG	●	●	●	-	-	-	-
Softening Lens ¹	/SL	●	●	●	-	-	-	-

Key

- Available with all beam angles.
- Not available

Notes:
¹ Softening lens supplied as standard.

Micro 50

Dimensions

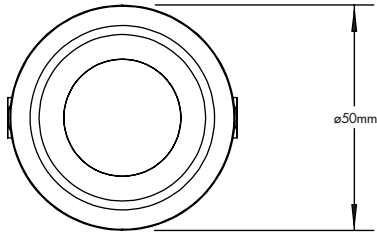

Ceiling cutout: \varnothing 46mm
Max ceiling thickness: 3 - 25mm

XOB - Product Height

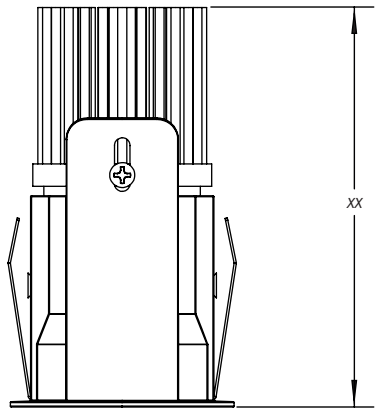

Narrow Spot Lens 15° / Narrow Lens 25° / Medium Lens 35°

Designer Series CRI90

500lm	90mm
700lm	90mm
1000lm	90mm

Paint Finish

Bezel

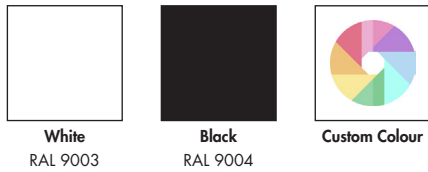

Circuit Wattage

XOB - Total Circuit Wattage

Narrow Spot Lens 15° / Narrow Lens 25° / Medium Lens 35°

Designer Series CRI90

500lm	5.9W
700lm	7.6W
1000lm	9.8W

